



PhiCleaner™ E22L

PV panels cleaning robot PhiCleaner™ manual

Please read this manual carefully before
using the product and keep it properly.

Kwunphi into possible, Kwunphi into habit.

焜出可能，焜成习惯

Directory

- 1.Safety instructions1
- 2.Attention1
- 3.Product introduction 2
- 4.Use guide6
- 5.APP Use guide21
- 6.Replacement of accessories27
- 7.Daily cleaning and maintenance29
- 8.Recommended Operating Conditions30
- 9.Troubleshooting34
- 10.New PhiCleaner Limited Quality32
- 11.Warranty and after-sales service36

1. Safety instructions

Before using this product, please carefully read all safety and operation instructions in this manual. Operation in violation of the manual may cause danger or damage to the equipment.

2. Attention

1. Use the product as instructed in the manual. Only use the accessories recommended or sold by the manufacturer.
2. Make sure the supply voltage meets the voltage specified on the charger.
3. Before using the product, make sure that the battery and shell have been installed in place, and the battery power is sufficient.
4. If the power cord is damaged, it must be replaced by the manufacturer, its maintenance department or a professional to avoid danger.
5. Please turn off the power switch or pull the plug from the power socket before cleaning and maintaining the product.
6. In case of power failure, waterproof covers must be installed on connectors and sockets, and ensure that the waterproof covers are clean and free of foreign matter.
7. Before placing the PhiCleaner in the initial position of the photovoltaic array, ensure that the surface of the initial position is clean in advance to prevent the product from slipping or falling due to serious pollution of the track.
8. After cleaning job, clean the anti-fall sensor with a wet towel and then wipe it with a dry towel to prevent excessive accumulation of dust and affect the perception.
9. Before discarding the product, turn off the power switch and remove the battery. Remove and discard the battery in accordance with local laws and regulations.
10. If the product is not used for a long time, please turn off the power switch and power off the product.
11. Wear ESD gloves when touching the PhiCleaner.
12. It is only used in the PV array with an inclination of less than or equal to inclination 15° (dry brush) or 10° (wash), the PV array edge range of 50cm is free of obstacles and the lowest point is suspended above 8cm.
13. Do not use the product in an extremely hot (above 45°C) or extremely cold (below -20°C) environment.
14. Safety protection devices such as guardrail and protective shed should be built around the photovoltaic array to prevent safety accidents.
15. When the product is operated at a height above 2m (including 2m) which is likely to fall, it shall follow the Technical Specification for Safety of Operation at Height in Construction.
16. Do not use the product when it cannot work normally due to drop or damage. To avoid injury, the product should be repaired by the manufacturer or its after-sale service.
17. Please use the product according to the instructions in the manual. Kwunphi company is not responsible for any loss or injury caused by improper use.

3. Introduction

3.1 Name & Model

Name: PhiCleaner

Model: E22L

3.2 Parts list

No.	Name	Quantity
1	PhiCleaner body (model: E22L)	1 pcs
2	Track	2 pcs
3	Battery	2 pcs
4	Recharger	1 pcs
5	Kit (wrench & clamp pliers & cross screwdriver & plumber's tape & water saving nozzle)	1 pcs
6	Rolling brush assembly (default type D)	2 pcs
7	Shoulder straps	1 pcs
8	Water Cube	1 pcs
9	Operating instruction	1 pcs

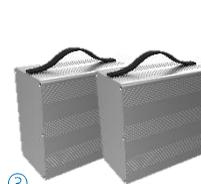

* According to different areas, choose different models of chargers.

* Due to the needs of continuous improvement of the product, this material product is subject to the physical, our company reserves the right to update the product.

3. Introduction

3.3 Optional accessories

Water cube	The battery	4G network module	M4 hexagon socket wrench	5.5-7 open end wrench
DS type front roller brush	The charger	Central suction cup	M5 inner hexagon wrench	8-10 Open end wrench
DS type rear roller brush	YR type track	Dust cover for central suction cup	M8 inner hexagon wrench	13-15 Open end wrench
DMM type front roller brush	YY type track	Vacuum filter	Circlip pliers	16-17 Open end wrench
Shading brush	Shoulder straps	Phillips screwdriver	Plumber's tape	Water saving nozzle

3.4 Roll brush type description

Width Type	Effective cleaning width	Density Type	Brush Density	Front Roller Brush	Rear Roller Brush	Applicable PV panel size type
D	800mm	S	Sparse	○ Optional	● Standard	125mm(125mm) M2(156mm) G1(158mm) M4(162mm) M6(166mm) M10(182mm)
		MM	Dense	● Standard	-	

3.5 Specification

Model	E22L
Operating system	TianyunOS
Battery	25.2V 15.3Ah
Recharger out	29.4V=5A
Battery life	≈270min
Charging time	≈180min
Weight	17.05Kg / 19.7Kg(Included battery)
Size	L 585mm * W 560mm * H 250mm



* The illustrations in this manual are for reference only. The actual appearance shall prevail.

* The actual data of battery life may be different due to different operating environment, load bearing, long-term battery loss and other factors.

* Equipment weight and size may vary slightly depending on material supplier, etc.

3. Introduction

3.6 Water Cube

3.6.1 Water Cube connection

1. Secure the base of the Water cube rotating table module to the Water cube mounting hole on the cover using M4 hex bolts.
2. Connect the pipe quick connector (M14 internal thread) at the lower end of the rotary table module to the inlet of the rolling brush water distributor.
3. Connect the external water pipe to the pipe (M14 internal thread) on the upper end of the rotating table module using a quick connector.

3.6.2 Water Cube quick release

After removing the connection with the rolling brush water distributor, remove the water cube rotating table module by flicking the Water cube quick release switch bolt outward on the lower surface of the base.

3.6.3 Tool

One M5 inner hexagon wrench, one M8 inner hexagon wrench, one 5.5-7 open end wrench, one 8-10 open end wrench.

3.6.4 Tightening and adjustment

Tightened or Adjusted parts	Tool
U-bolt	10 Open end wrench
Fixed screw nut for pipeline support frame	7 Open end wrench M4 hexagon socket wrench
Fixing screws for PVC pipe	M8 inner hexagon wrench
Set screws and nuts for PVC pipe supports	8 Open end wrench M5 Inner hexagon wrench

3.6.5 External device

Need to purchase their own high pressure cleaning machine and high pressure explosion-proof pipe used together.

Collocation demonstration(Washing Kit - Electric Basic Edition) :

- High Pressure Cleaner T1
- Pipe Collector Combination
- High Pressure Hose

Water cube quick release switch bolt

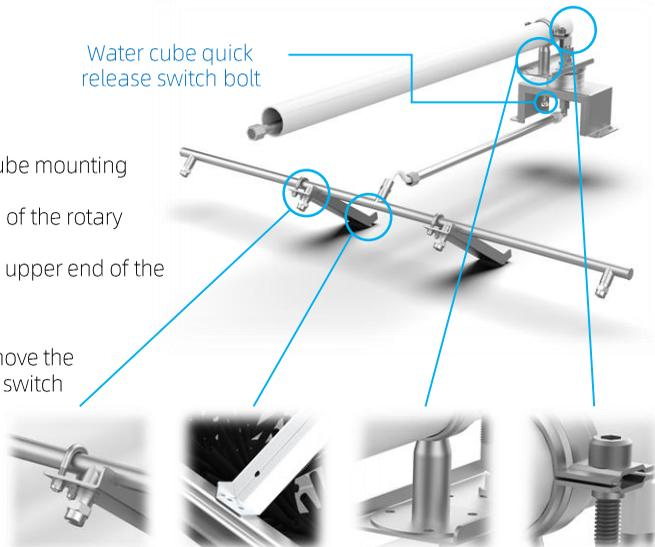

U-bolt

Pipeline support frame

PVC pipe support

Fixing screws for PVC pipe



* Manual duty is required when using the water cube to prevent pipe entanglement or pulling.

* The drag length of the pipe connecting the water cube to the pressure cleaner is recommended not to exceed 30 meters.

* For more tutorials on the application of Water cube and washing kit, please visit the official website.

3. Introduction

3.7 Module specification

No.	Module
1	PhiCleaner body
2	Case
3	Battery cover
4	4G Network module
5	Indicator light & Button
6	Handle
7	Crawler belt
8	Shading brush
9	Roller bracket holder
10	Roller bracket
11	Rolling brush connection part
12	Roller
13	Water cube
14	Water cube-mounting
15	Water cube-holder
16	Ultrasonic sensor
17	Exposure box
18	Central suction cup
19	Shoulder strap buckle

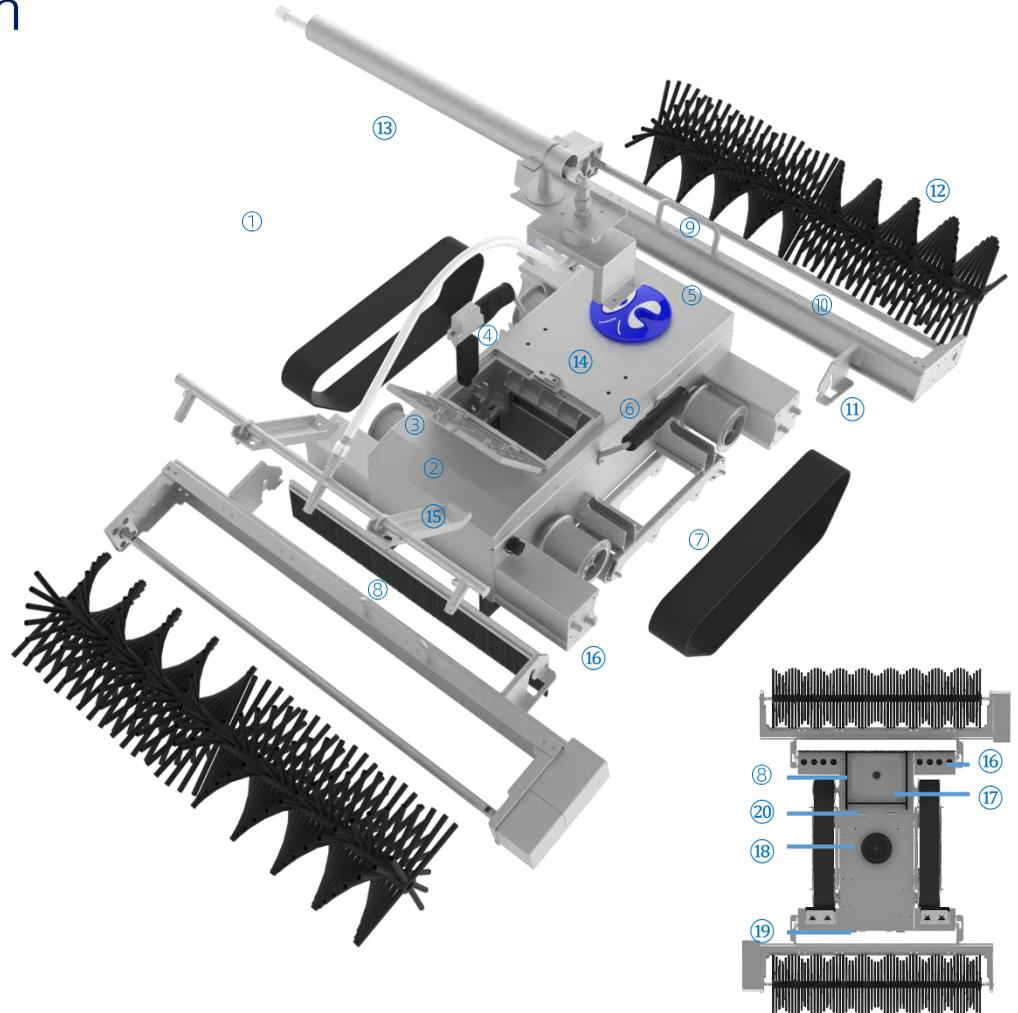

4. Use guide

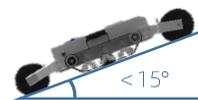
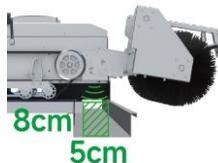

4.1 Application scenarios

1. PV array tilt less than 15° (dry brush) or 10° (wash). (This data ultimately depends on the characteristics of the contaminant.)
2. There are no obstacles in the PV array area, and the identification area at the bottom of the PV array edge is 5*8cm(width * depth) barrier-free.
3. The type and direction of the PV array modules are the same, and there are white intervals between the batteries of the modules.
4. The maximum dislocation less than 4cm of the upper, lower, left and right of the adjacent PV panel.
5. The spacing of photovoltaic modules is less than 4cm, and the height difference is less than 4cm.
6. The edge of the photovoltaic array is free of obstacles within a 50cm range. (If only the top is obstructed, you can use a custom limit on the number of rows to do not clean the top row)
7. The supported types of photovoltaic panel are as follows:

Main grid line	Type	Size(mm)	PCS
0BB	Full size	125	96
2BB	Full size	156	60
3BB	Full size/Half size	156/158	60/72
4BB	Full size/Half size	156/158	60/72
5BB	Full size/Half size	156/158	60/72
6BB	Full size/Half size	156/158	60/72
MBB	Half size	162/166	60/72
		182	60/72/54/66/78
		210	60/72/45/54/66/55
	One third	210	50

Obstacles such as walls and pipes should be within 50cm of the top edge of photovoltaic array

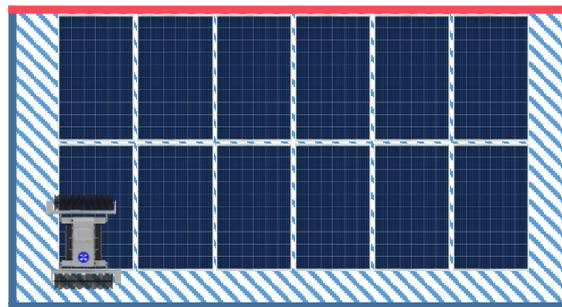

There are no obstacles within 50cm of photovoltaic array edge

The interval between PV array is less than 4cm

The height difference is less than 4cm

* In the case of self-identification, MBB default M6/166mm size, which can be customized.

* The main grid line 0BB PV module needs to define the relative placement direction of PhiCleaner: horizontal (H0BB) or vertical (V0BB).

* PCS automatic identification only supports 60/72. If the application scenario is fixed, you are advised to use the custom scenario mode.

* Safety protection devices such as guardrail and protective shed should be built around the photovoltaic array to prevent safety accidents.

* When the product is operated at the height above 2m (including 2m), which is likely to fall, it should follow the Technical Specification for Safety of Operation at High Places in Construction.

* Due to the needs of continuous improvement of the product, this material product is subject to the physical, our company reserves the right to update the product.

4. Use guide

4.2 Interactive instructions

4.2.1 Light color instruction



Pilot lamp	Appearance	Content
Red lamp1	Normally off	Drive sensors are all normal
	Normally on	The battery is low, need to be charged or replaced
		During the operation, the driving failure will automatically switch to standby mode, which needs to be restarted and repaired
	2.50Hz flashing	There is an abnormality in the left ultrasonic anti-fall sensor
	1.25Hz flashing	There is an abnormal ultrasonic drop sensor on the right side
	0.50Hz flashing	There is an abnormality in the pressure or temperature detection module
Red lamp2	Normally off/Normally on	Internal communication of the device is normal/failed
	flashing	When standby, if startup conditions are not met, the device shall be completely placed on the PV surface with an inclination less than 15°
		When turning, the central sucker is lowered to complete the sucker, but the adsorption effect is not good, unable to meet the turning conditions
Green lamp	Normally on	Standby
	flashing	Autonomous operation/remote control/remote control status
Yellow lamp	Normally off/Normally on	The network status is normal or the remote control takeover / network status is abnormal

4.2.2 Buzzer

Ringling times	One ringling	Continued ringling
Content	Operation mode switching	Actuator error fault alarm
	The bottom layer of the communication change	Operation abnormal alarm

4. Use guide

4.2 Interactive instructions

4.2.3 Button



Power button

Power on or off



Start/Standby button

Start or cancel autonomous jobs
Turn off the buzzer alarm

4.2.4 Autonomous mode

Barriers, such as walls and pipes, are within 50cm of the top edge of the photovoltaic array

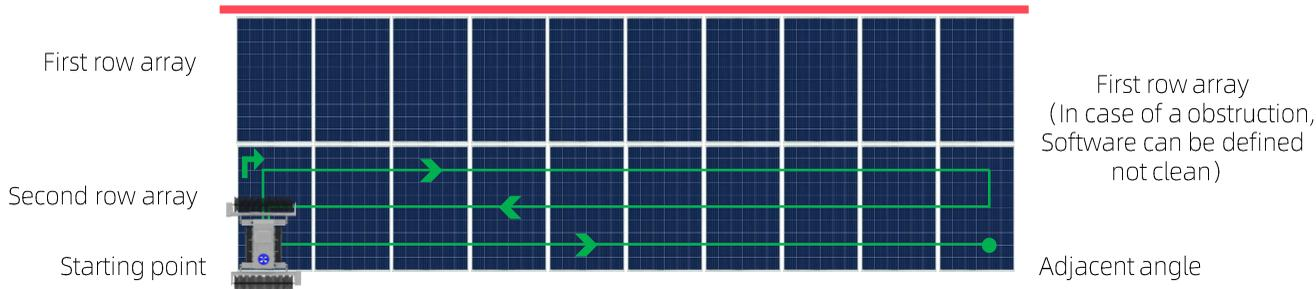

Content	Option	Timing	Default
Type of PV module	Full size/Half size/One third	Standby	Full size
Grid line, size, number of pieces	Automatic recognition or custom patterns	standby	Automatic recognition
Anchor pattern	Berthing at start point/Adjacent angle	Standby	Berthing at start point
Cleaning tasks	1 ~ 10/999 times	Online	1 time
Array row limit	No limit/1 ~ 100 rows	Standby	No limit
Cleaning mode	Array/Single bottom Quick/Normal/Deep/Severe	Standby	Array Normal

4. Use guide

4.3 How to Use batteries

4.3.1 Charging

1. Ensure that the battery is not working. Take out the battery or spare battery.
2. Insert the output port of the charger into the XT60 port of the battery.
3. Insert the input plug of the charger into the 220V power socket, and then turn on the power supply of the socket.
4. Wait until the red light of the charger turns on and the battery starts charging.
5. It takes about 3 hours to fully charge, when the red light of the charger is off, the green light is on, and the charging is finished.
6. Turn off the power from the socket and remove the input plug of the charger.
7. Remove the battery from the outlet of the charger and store it.

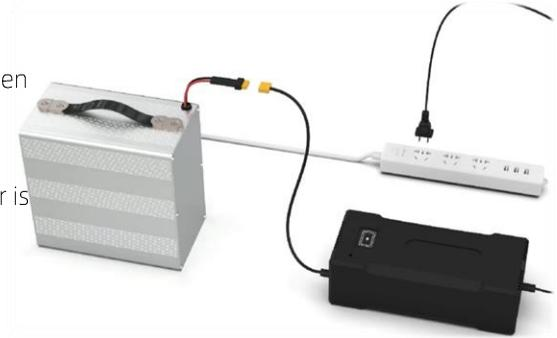

4.3.2 Battery installation

1. Remove the bolts securing the battery cover using an M4 hexagon key.
2. Align the battery, and connect the battery outlet to the XT60 port on the opposite side of the connection port.
3. Close the battery cover and tighten the bolts using an M4 hexagon key.

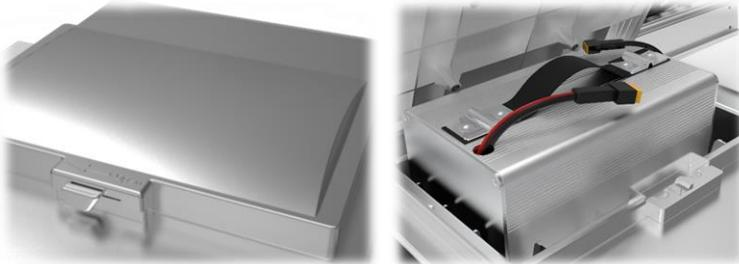

* For more tutorials and videos on how to use PhiCleaner, please visit our official website

4. Use guide

4.4 How Do I Use 4G Network Modules

1. Open the battery cover and remove the 4G network cover using a Phillips screwdriver.



2. Take out the 4G network module, remove the cover, insert the Nano SIM card, and restore the installation.

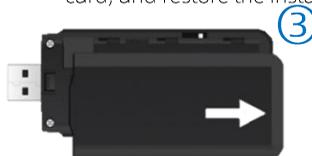

4.5 How to Use roller brush

1. Hold the roller brush holder and lift the roller brush holder. Insert the flange bearing connecting the roller brush holder.

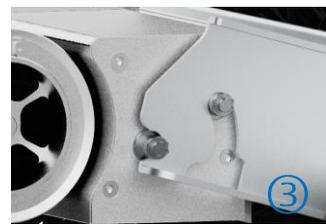
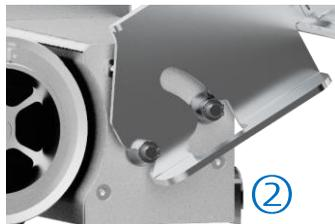
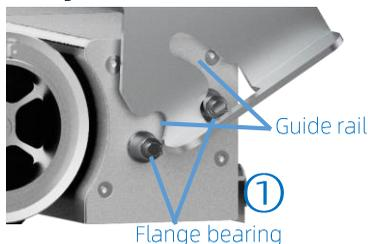

2. Ensure that the air socket is powered off, open the waterproof cover, connect the air socket according to the limit prompt, and complete the installation.



* For more tutorials and videos on how to use PhiCleaner, please visit our official website

4. Use guide

4.5 How to Use roller brush

- * In double roller brush cleaning mode, roller brush components are not front and rear, and can be exchanged at will.
- * Do not use single rolling brush cleaning mode to avoid falling risks.

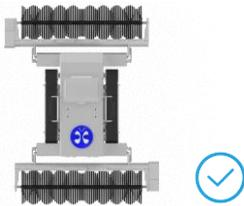

- * Install the rolling brush before powering on the equipment, otherwise the rolling brush may not complete the operation.

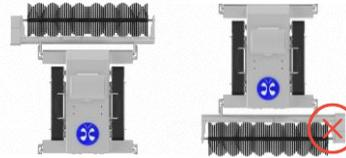

- * Make sure the aviation plug is fully inserted according to the limit prompt and the spring button is up.



- * Do not install the limit bolt of the roller brush assembly askew, otherwise the screw hole will be damaged.



- * For more tutorials and videos on how to use PhiCleaner, please visit our official website

4. Use guide

4.6 How to use this product

4.6.1 Pre-operation inspection

4.6.1.1. Check **track surface** cleanliness to prevent significant loss of grip. (It is forbidden to lift the upper hanging part of the track to prevent deformation and damage of the front and rear axles)



4.6.1.2. Check whether there are foreign bodies under the anti-fall sensor to prevent abnormal anti-fall perception. (It is strictly forbidden to be squeezed by external forces)



4.6.1.3. Check that the battery cover is firmly closed.



4. Use guide

4.6 How to use this product

4.6.1 Pre-operation inspection

4.6.1.4. Check the cleanliness of the suction cup surface at the bottom of the central sucker assembly to prevent a significant reduction in grip.

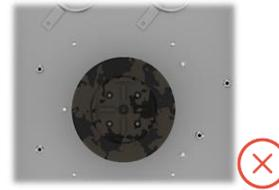
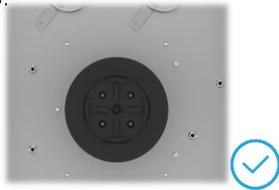

4.6.1.5. Check whether the cleanliness of the camera lens and the body of the exposure box and the shading plate completely cover the projection plane area of the exposure box to prevent sunlight and dust from interfering with the camera.

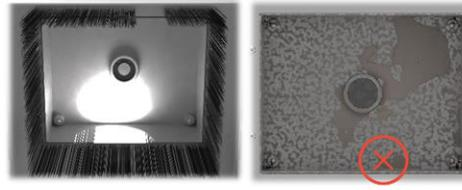
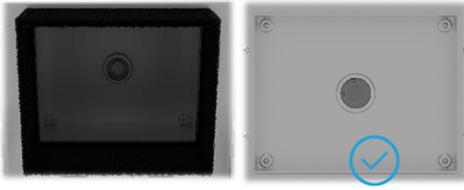

4.6.1.6. Check the type of roller brush and whether it is deformed to prevent the cleaning effect. (Refer to "Description of Brush Component Types" on page 3 for usage scenarios corresponding to brush types.)



- * When the roller brush is idle, should be on the motor, erect rely on placing, Avoid compression deformation of roller brush bristles.
- * If the bristles are deformed under pressure for a long time, It will cause the bristles to become irreversibly deformed.
- * When moving the roller brush, special handle should be raised. It is strictly forbidden to pull the roller brush shaft to prevent deformation and damage of the roller brush shaft.

* For more tutorials and videos on how to use PhiCleaner, please visit our official website

4. Use guide

4.6 How to use this product

4.6.2 Placing

1. The number of turns is equal to the number of turns in a single row multiplied by the number of array rows.

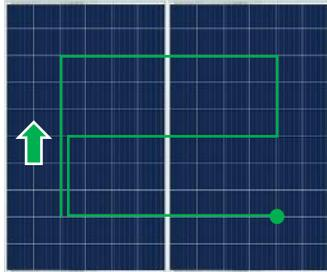

Vertical layout(V)
Three turns in a row



Horizontal layout(H)
Six turns in two rows
A row requires two turns
Crossing requires two turns

2. Select the starting point with the least number of turns for H autonomous operation.

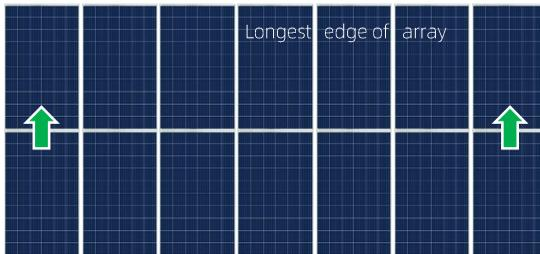

Turn times of V autonomous operation=8

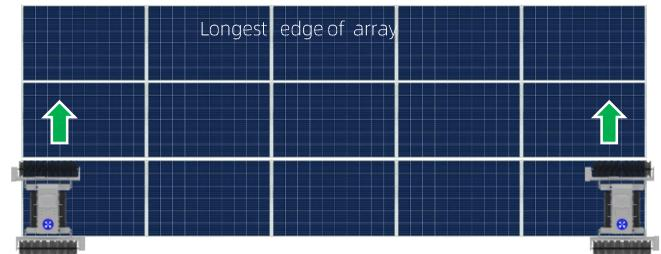

Turn times of H autonomous operation=10

3. Generally, use the side that is easy to carry and operate the device as the starting end, that is the bottom of the array.

* Ensure that the surface of the initial position is clean to prevent the product from slipping or falling due to heavy contamination of the tracks

4. Use guide

4.6 How to use this product

4.6.3 Start the PhiCleaner

1. Corner placement

Select the starting point with the least number of turns for horizontal autonomous operation.

PhiCleaner is placed on the bottom corner of the left and right sides of the photovoltaic array that meets the requirements.

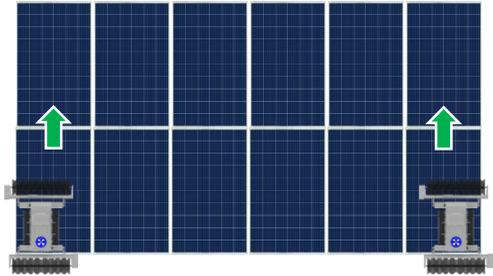

PV panels apart less than 4cm
PV panels height difference less than 4cm



The identification area at the bottom of the PV array edge is 5*8cm (width * depth) barrier-free.

2. Turn on the power

Press the power button to start the device. When the first red light is often off (the buzzer rings once), the device is normal and enters the initialization state.



* Ensure that the surface of the initial position is clean to prevent the product from slipping or falling due to heavy contamination of the tracks

3. Position calibration

Adjust the horizontal central axis of the device to the spacing line of the cells in row 2 and row 3 in the lower corner, and the horizontal central axis to the spacing line of the cells in row 2 and row 3 in the lower corner.

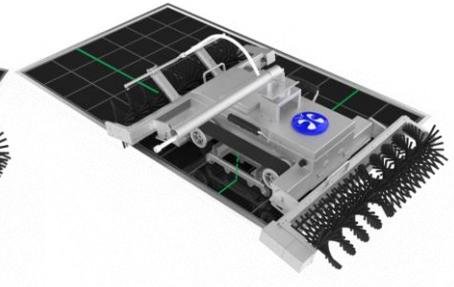
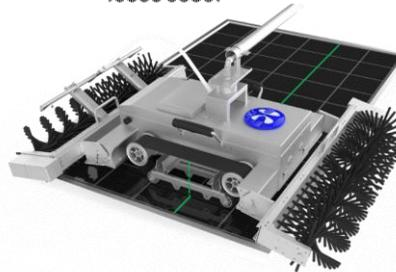
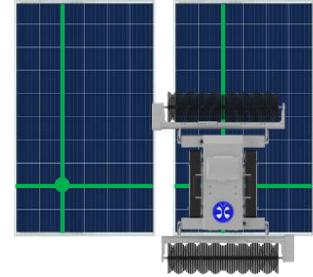
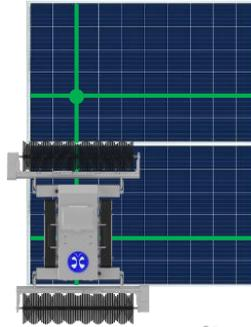

* Holes on the support plate of the synchronous wheel indicate the central position of PhiCleaner, which can assist in position calibration.

* The main grid line 0BB PV module needs to be closer to the interior due to size problem, and should be placed according to the number of rows and columns + 1 indicated above.

4. Start the job

When the green light is always on and the red light is often off, the device is normal and the initialization is successful, then press the Start/Standby button to make the device start autonomous operation.



4. Use guide

4.7 Function application

4.7.1 Unmanned cleaning / 4.7.1.1 Array

After the start and identification is completed, the PhiCleaner climbs up to the top of the photovoltaic array and tries the direction. After the direction is determined, the operation begins. The PhiCleaner turns around to span until the array is covered, and chooses the termination according to the berthing mode.

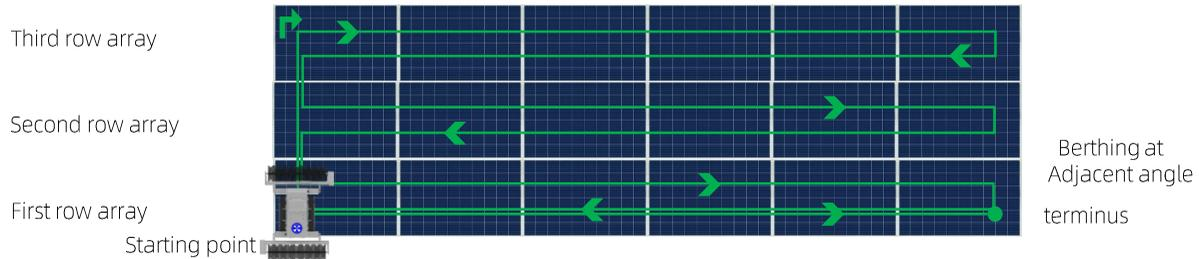
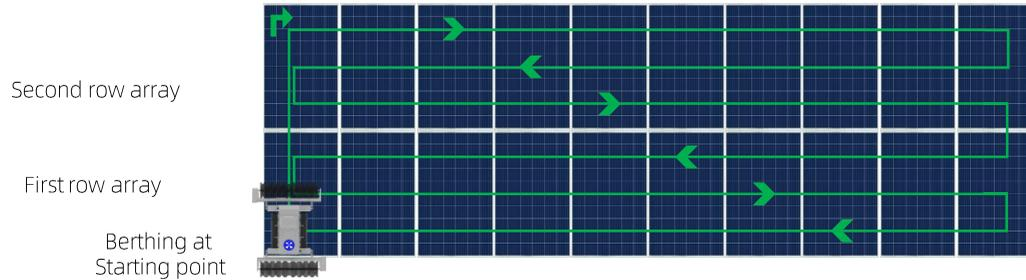

4. Use guide

4.7 Function application

4.7.1 Unmanned cleaning / 4.7.1.2 Single bottom

After the start and identification is completed, the PhiCleaner independently operates forward to the edge of the photovoltaic array to complete the single bottom edge operation. (Recommended for cleaning array ash zone)

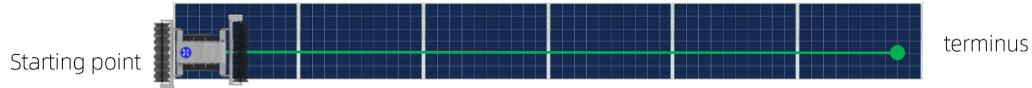

* If the bottom edges are stubborn stains, it is recommended to use single bottom/severe cleaning mode for cleaning.

4.7.2 Low voltage return

In the process of autonomous operation, when the battery power is low, the PhiCleaner will automatically enter the low-voltage return mode and return to the starting position.

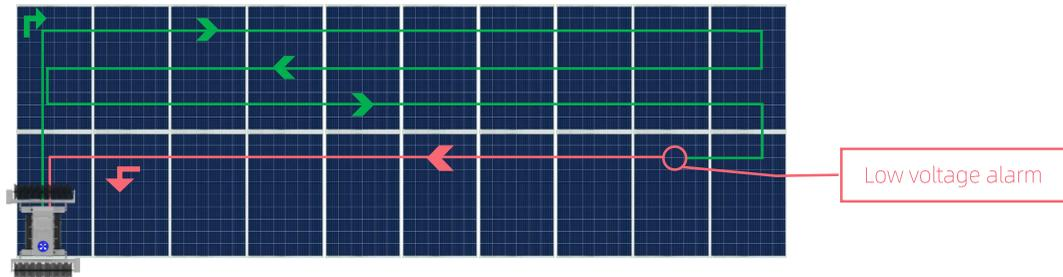

4. Use guide

4.7 Function application

4.7.4 APP monitoring

Basic interaction
operations
PhiCleaner status display and mode customization
Settings and other



Remote control
joystick and button modes manually control
PhiCleaner movement

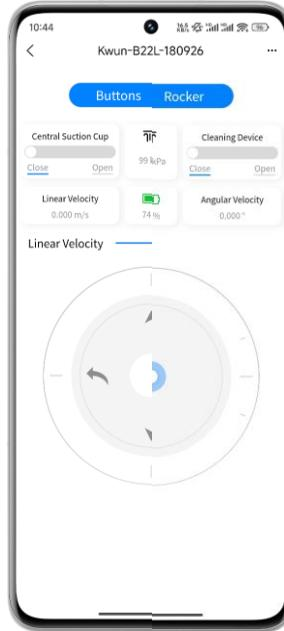

OTA
Software application in the air
download upgrade

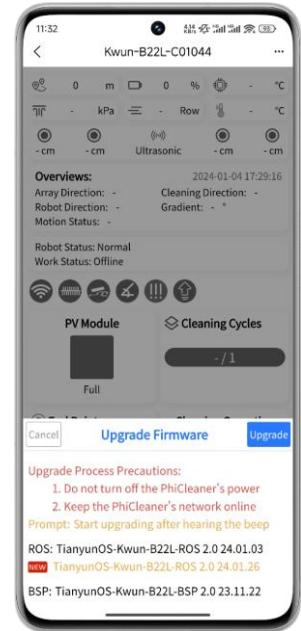

* Remote control mode is a header mode with PhiCleaner itself as the reference coordinate system,
* Instead of headless mode with geographic or operator reference frames.

* For more APP tutorials, see Chapter 5 APP Usage Guide

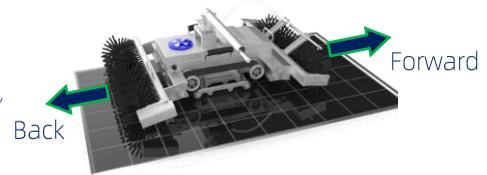

4. Use guide

4.8 Technical solution of connecting bridge

4.8.1 The role of the bridge

During the installation layout design, corridors are reserved around the array. Under normal circumstances, the equipment cannot automatically cross gaps/corridors exceeding 5cm when operating independently. Therefore, when reaching the left and right edge aisles, turn around to continue the operation, and when reaching the front and rear end edge aisles, turn around to complete a cleaning task.

If the number of PV array is small, the time to complete an independent array is fast, and the frequency of moving or remote control to adjacent arrays is high. Under the condition that safety conditions are met, the connecting bridge connects multiple photovoltaic arrays horizontally or longitudinally to minimize the Times of equipment handling or remote control and improve work efficiency.

4.8.2 Straddle bridge

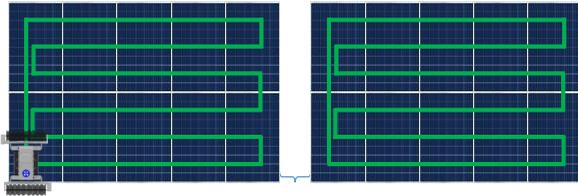

For example, the interval is 56cm

A total of six decks were laid

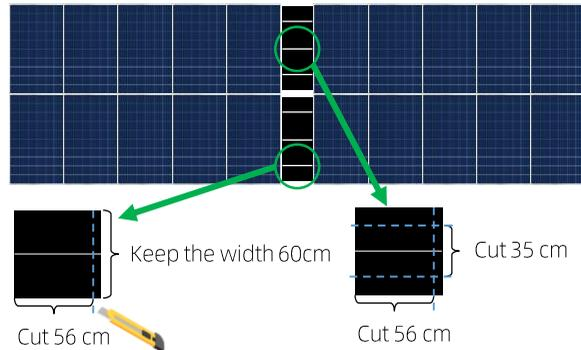

A black bridge deck with a width of 600mm and a virtual guide line with a width of 4~6mm white was laid horizontally along the operation track along the adjacent array aisle at the left and right ends.

The virtual guide line simplifies the surface texture of PV panel and only highlights the spacing stripes between PV cells.

In this way, the bridge deck will be simulated to replace the PV panel. PhiCleaner will use the virtual main gate line along the bridge deck as the guide to successfully pass through the bridge deck and complete the cross-array operation.

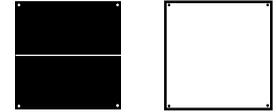
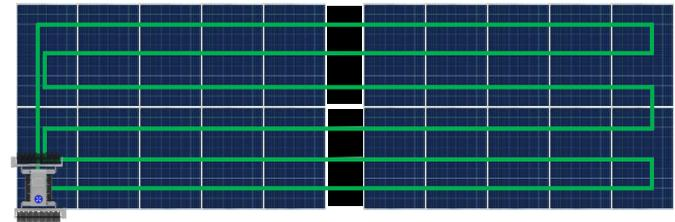

4. Use guide

4.8 Technical solution of connecting bridge

4.8.3 Cross link bridge

Due to safety reasons, the cross-bank process is technically limited.

If it is exceeded, an alarm will be sounded and autonomous operation will be interrupted.

Therefore, the length of the cross-line connection bridge is only allowed to be less than or equal to 35cm.

That is, you can use this method only when the distance between the front and rear ends of the PV array is less than or equal to 35cm.

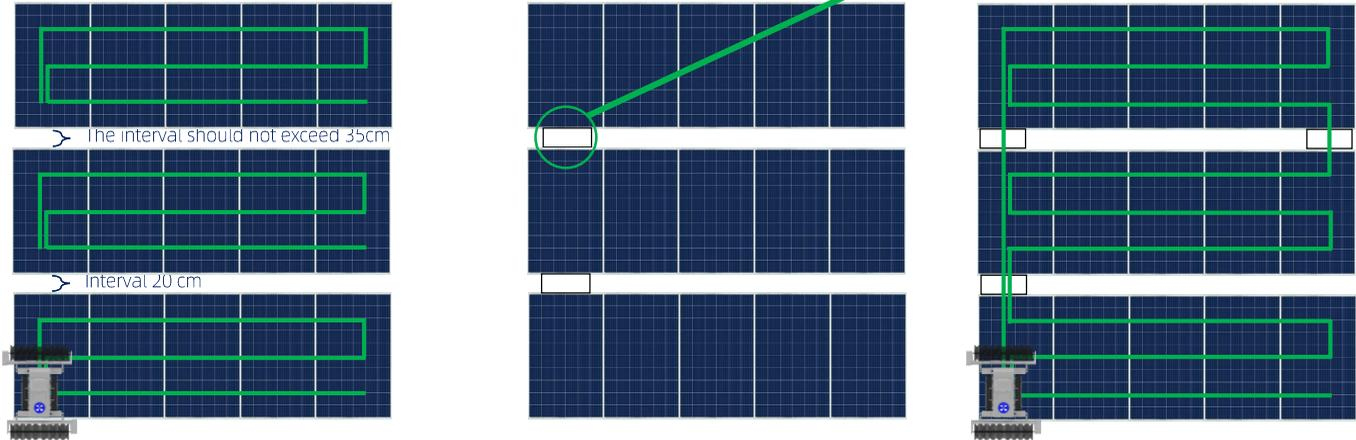

A clean bridge deck without guide wires is laid horizontally along the PhiCleaner's operation track on adjacent array aisles at the front and rear ends.

In this way, the bridge deck simulates replacing gaps between photovoltaic modules while meeting the height requirements of the plane, PhiCleaner will guide driving along the bridge deck without a straight line for a short time to pass through the bridge deck until stepping into the new array, and start the covering cleaning operation of the new array.

* For more information about E22L connection bridge construction, please visit the official website

5. APP Use guide

5.1 Software download

5.1.1 Android link

<https://file.kwunphi.com/app/aikwun/android/aikwun.apk>

5.1.2 iOS link

<https://apps.apple.com/us/app/id1616848453>, or search for "AI-Kwun" in the App Store.

5.2 Device connection

5.2.1 Account registration

- * Need to insert Nano SIM card
- * Main traffic usage scenario: device interface interaction is about 3.2KB/s, and one OTA is about 1-50MB
- * For specific operations, please refer to section 4 "How to Use 4G Network Module" in Chapter 4 "User Guide".

Scan QR code by browser



Android version APP



iOS version APP



Click the register button

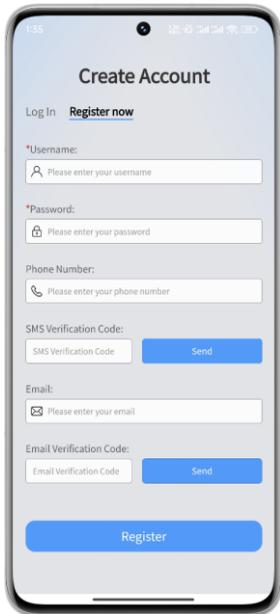

Fill in relevant information



Login to the Home page



5. APP Use guide

5.2 Device connection

5.2.2 Login



Enter the device list interface
Click the login button
Enter your account number and password

5.2.3 Device list



Click device
The device home screen is displayed

Click Cleaning task
The cleaning task page is displayed

Click settings
With more Settings



* You can switch between English and Chinese on the login screen or set language options on the screen to enter the language setting screen

* For more tutorials on the APP, please visit the official website

5. APP Use guide

5.2 Device connection

5.2.4 Add equipment

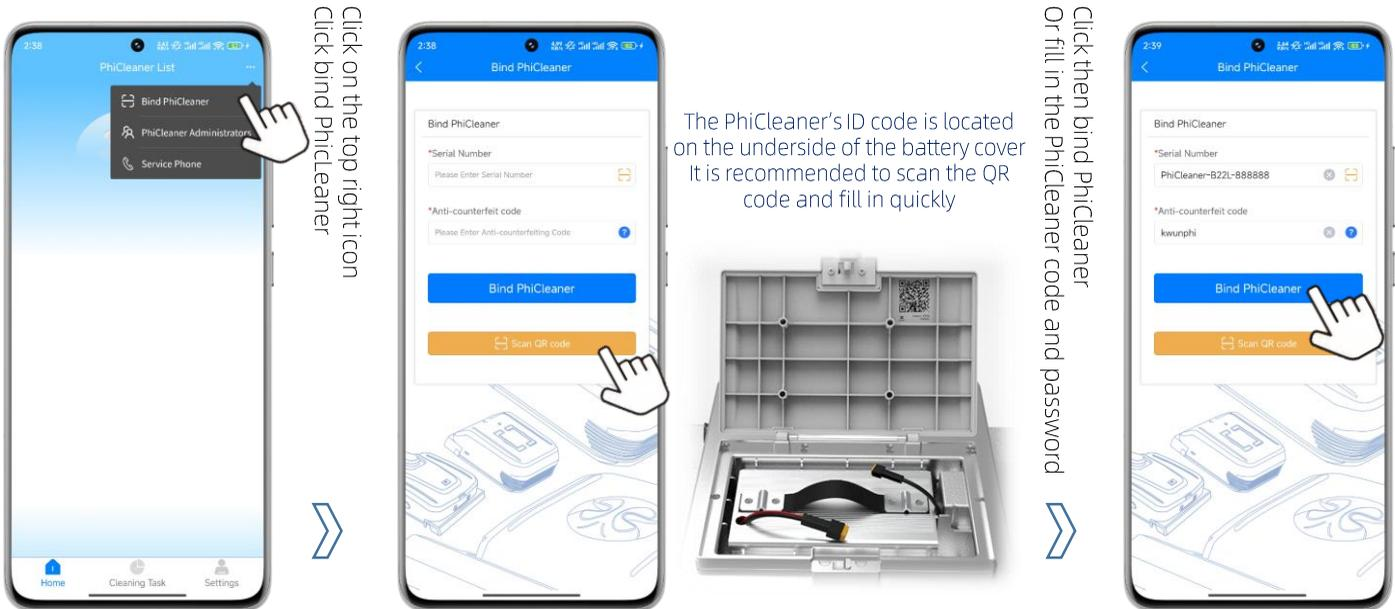

* For more tutorials on the APP, please visit the official website.

5. APP Use guide

5.3 Device Interaction / 5.3.1 Basic Interaction

PhiCleaner ID

Mileage, temperature, line count and battery status display

Overviews

Customize function ICONS
Wi-Fi function, brush speed regulation, slippage monitoring, Angle limit, etc

PV type displayed
Click the icon to customize

End Point mode setting

The joystick control
Click the button to enter

more functions

Anti-fall sensor shows

Login / Off-line time record

Device status display

Cleaning Cycles
Click the icon to switch

Cleaning Operation
Click the icon to switch

Array row limit
Click on the icon to switch

Start the device remotely
Click the button to set

2:50
Kwun-B22L-180926
8.31 km 96% 51 °C
101 kPa 0 Row 35 °C
5.4 cm 5.2 cm Ultrasonic 4.9 cm 5.3 cm
2024-02-02 14:45:31
Array Direction: - Cleaning Direction: -
Robot Direction: Up Gradient: 1 °
Motion Status: Static
Robot Status: Normal
Work Status: Hold
PV Module
Full 5BB M2 60PCS
Cleaning Cycles
0 / 1
End Point
Starting Corner
Cleaning Operation
Array/Normal
2
Array Row Limit

5. APP Use guide

5.3 Device Interaction

5.3.3 Other interactions

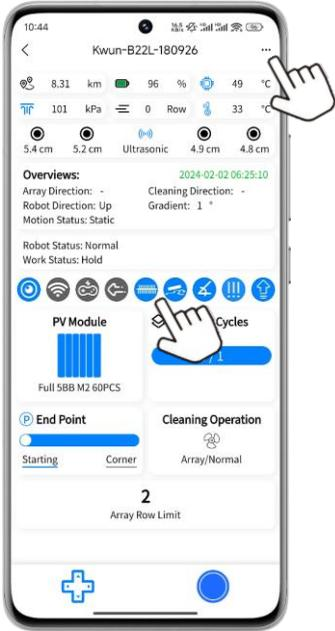

Cleaning Jobs

Click on the icon



Roller speed

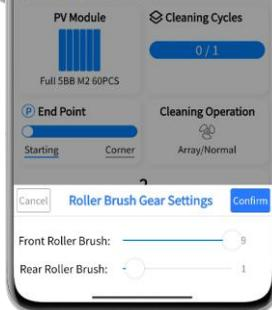
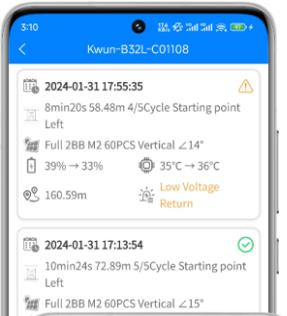

User Manual

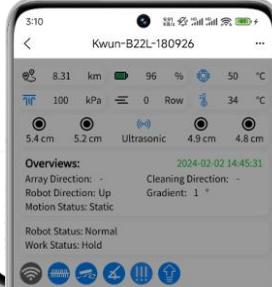

Wi-Fi Settings

Running Log



OTA

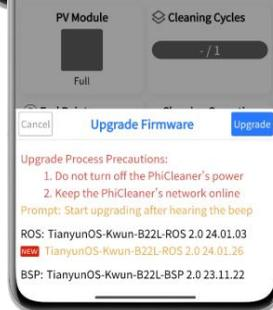

* For more tutorials on the APP, please visit the official website

5. APP Use guide

5.4 Device management



Click more ICONS



Remark

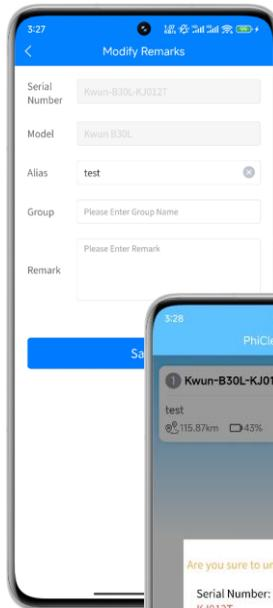

Share

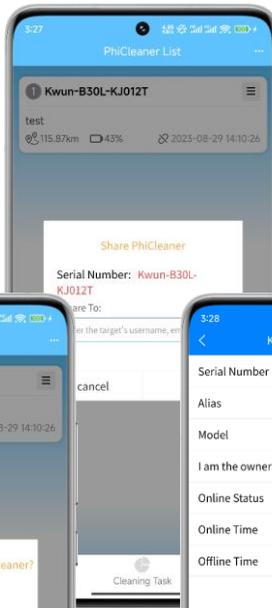

Administrators



Unbind



Properties

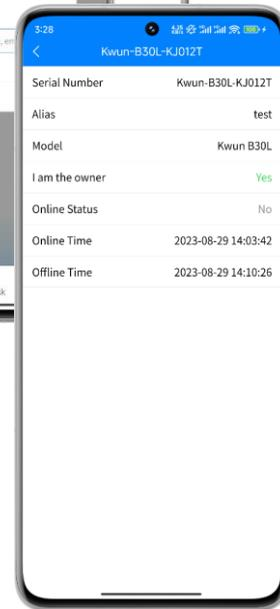

6. Replacement of commonly used accessories

6.1 Battery replacement/low power condition (about 270min when full power works)

1. Turn off the power and make sure the power is off
2. Unscrew the battery cover retaining bolt and open it
3. Take the battery out
4. Place the spare battery in alignment
5. Close the battery cover and tighten the retaining bolts

6.2 Replacement of roller bracket/failure to meet the requirements of cleaning or handling

● Brush roller bracket mounting

1. Hold the handle of the brush holder with both hands to lift the brush holder, and place the corresponding flange bearing of the rotating slide of the brush holder.
2. Tighten the limit holes on the left and right sides with limit bolts.
3. Make sure the power cable of the roller brush is off. Connect the power cable of the roller brush to the installation.

● Brush roller bracket be removed

1. Prepare the M3 hexagon wrench to ensure the roller brush is not working and disconnect the power cable of the roller brush.
2. Use the M3 hexagonal wrench to unscrew the right and left roller brush limit bolts.
3. Hold the handle of the brush holder with both hands and lift the brush holder along the rotating slide to disassemble.

6.3 Replacement of roller brushes/failure to meet cleaning requirements

1. Unscrew the bolts connecting the rotating shaft of the brush holder to the rotating shaft of the brush holder using an M4 hex key.
2. Rotate the roller brush 90° to align the opening of the roller brush shaft with the rotating axis surface, and remove one side of the roller brush.
3. Repeat steps 1 and 2 to remove the roller brush on the other side and remove the old roller brush.
4. Select one side of the rotating shaft surface corresponding to the opening of the replacement roller brush shaft and insert it.
5. Rotate the roller brush 90° to align the shaft hole of the roller brush with the thread hole of the rotating shaft.
6. Screw the bolts connecting the rotating shaft of the brush holder to the rotating shaft of the brush holder using an M4 hex key.
7. Repeat Steps 4, 5, and 6 to assemble the roller brush on the other side and tighten bolts on both sides to replace the roller brush.

* For more tutorials and videos on commonly used parts replacement methods, please visit the official website

6. Replacement of commonly used accessories

6.4 Crawler belt replacement/severe wear or contamination

1. Prepare the replacement track, circlip pliers, 16-17open wrench, and M4 allen wrench, and prop up the PhiCleaner body to lift the track off the ground.
2. Use No. 17 open end wrench to unscrew the screws on the driving wheel.
3. Then use the M4 Allen wrench to unscrew the four fixing screws of the drive reinforcing plate, then remove the reinforcement plate.
4. Use the circlip pliers to remove the circlip of the driving wheel and the driving wheel, and remove the outer stop ring of the driving wheel and the driving wheel.
5. Reach into the inside of the track and balance it out to complete the track disassembly.
6. Take out the replacement track and install it.
7. Insert the track into the drive wheel, driven wheel and synchronous wheel in turn, and then press the track into parallel until it is close to the inner stop ring of the drive wheel.
8. Install the outer stop ring to the outside of the driving wheel and the driven wheel, and use the circlip pliers to cover the circlip grooves of the driven wheel and the driving wheel respectively.
9. Check to make sure that all the driving wheel and the outer stop ring of the driven wheel are inside the circlip groove.
10. Align the reinforcement plate with the hole and install it, and ensure that the driven wheel shaft and drive wheel bearing are fully stuck in the reinforcement plate.
11. Use a wrench to reset and tighten all screws.

* Track used for a long time, its surface becomes smooth and loses friction, 1000 mesh sandpaper can be used to grind the track surface diagonally to increase friction.

6.5 Replacement /Damage of the central sucker

1. Prepare the M4 hex key, and erect the PhiCleaner body.
2. Loosen the four bolts on the central suction cup and the four bolts on the pressure ring of the dust ring using an M4 hexagon socket wrench.
3. Remove the dust jacket from the rotor of the rotary table.
4. Make use of the scalability of the new dust jacket to stretch the central through hole into the rotor and stator of the rotating table.
5. Put the pressure ring on the dust cover and press the dust cover on the body base and align with the screw hole.
6. Tighten the pressure ring on the dust cover and secure the dust cover to the base by inserting four bolts using an M4 hex key.
7. Connect the central sucker to the rotor hole of the rotary table, and tighten the four bolts using an M4 hex key.

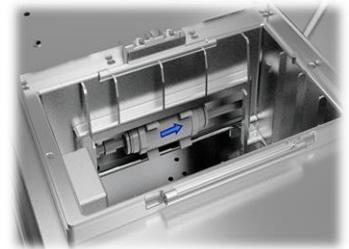

6.6 Vacuum filter replacement / serious water accumulation or ash accumulation

1. After removing the battery, remove the vacuum filter from the vacuum filter holder.
2. Press the quick change pipe connector of the air inlet, and remove the air inlet pipe connected by the three-way pagoda connector.
3. Press the quick change pipe connector of the air outlet and remove the air outlet pipe connected through the pagoda connector.
4. Check the label of inlet and outlet of the shell of the new vacuum filter.
5. Press the outlet pipe directly connected to the pagoda connector into the outlet quick change pipe connector.
6. Press the air inlet pipe connected by the three-way pagoda connector into the quick change pipe connector of the air inlet.
7. Clamp the vacuum filter into the vacuum filter holder.

* For more tutorials and videos on commonly used parts replacement methods, please visit the official website

7. Daily cleaning and maintenance

PARTS	Store	Timing of cleaning	Cleaning way
PhiCleaner	Turn off the power, and do not store in high temperature, humidity or sun exposure	About 270 minutes of interval work or serious ash	Clean the surface with a soft cloth
Water cube	Dump all the water, and do not store in high temperature, humidity or sun exposure environment		
Battery	Do not store in the environment of high temperature, humidity or sun exposure and every 1.5 months to replenish electricity, prevention of over-discharge of the battery	-	-
Roller brush	Do not store in high temperature, humidity or sun exposure	About 270 minutes of interval work or serious ash	Use a soft cloth to comb up and down and wind, do not wash with water
Crawler belt			<ol style="list-style-type: none"> 1. Place the wet rag on a flat surface. 2. Enter remote control mode through APP to move the device to drive the track cleaning.
			<ol style="list-style-type: none"> 1. Overhead fixed equipment. 2. Press wet rag or foam onto the track. 3. Move the track in remote control mode through APP to drive the track cleaning.

8. Recommended Operating Conditions (ROC)

Clean way	Project	ROC	Data source
Dry Brushing	PV panel Angle	0~15°	Measured in South China before February 2022
	PV panel surface temperature	-20~80°C	
	The environment temperature *	-20~50°C	
	PV panel Gap	40mm	
	PV panel Height difference	40mm	
	Rainfall	Water Washing Angle	
	Wind power	62~74Km/H Fresh Gale	
	IP Rating	IP65	
Water Washing	PV panel Angle	0~10°	
	PV panel surface temperature	0~80°C	
	The environment temperature *	0~50°C	
	PV panel Gap	40mm	
	PV panel Height difference	20mm	
	Rainfall	25~50mm Light Rain	
	Wind power	29~38Km/H Fresh Breeze	

* Continuous working time varies with ambient temperature, PV panel angle data ultimately depends on the characteristics of the contaminant.

9. Troubleshooting

Trouble	Probable cause	Troubleshooting measure method
Device cannot start up	<ol style="list-style-type: none">1. Low battery2. Inaccurate battery installation	<ol style="list-style-type: none">1. Use the battery after it has been fully charged2. Test whether the battery plug and install is reliable and accurate
Device cannot start autonomous operation	<ol style="list-style-type: none">1. Abnormal equipment state2. Component module surface damage3. The current scenario is not supported	<ol style="list-style-type: none">1. Check the abnormal state of the device by means of indicator light and APP, and repair the abnormal state2. Check whether the components are damaged or blocked by obstacles3. Detect the PV panel grid type and gradient
The autonomous operation was terminated abruptly	<ol style="list-style-type: none">1. Equipment failure2. Continuous damage of PV panel surface3. Misoperation of APP	<ol style="list-style-type: none">1. Check the abnormal state of the device through the APP device interface or log, and fix the abnormal state2. Check whether the PV panels are damaged or blocked by obstacles

10. New PhiCleaner Limited Quality Assurance

10.1 General warranty terms

The Warranty (Kwunphi) shall provide warranty services to PhiCleaner within the applicable warranty period in accordance with the terms, conditions and limitations of this " New PhiCleaner Limited Quality Assurance" . Your rights and obligations under this " New PhiCleaner Limited Quality Assurance" apply to the Warranty area in the hinterland of China (i.e. the area where you purchased the new PhiCleaner). If you transfer your PhiCleaner to another warranty area, the terms of this " New PhiCleaner Limited Quality Assurance" will no longer apply unless otherwise required by local law.

10.2 What's PhiCleaner?

PhiCleaner is a kind of unmanned autonomous photovoltaic panel cleaning robot designed and manufactured by Shenzhen Kwunphi Robot Co., LTD. Kwun has been registered as a trademark by Shenzhen Kwunphi Robot company, PhiCleaner is in essence a special noun of Shenzhen Kwunphi Robot company photovoltaic cleaning robot.

10.3 Who is the guarantor of quality?

Shenzhen Kwunphi Robot Co., LTD.

10.4 What's the warranty covers PhiCleaner's range

This " New PhiCleaner Limited Quality Assurance" applies to PhiCleaner sold by Kwunphi Robot company within the Warranty territory in the hinterland of China for the purpose of this " New PhiCleaner Limited Quality Assurance" .

The warranty area in the hinterland of China includes 23 provinces, 5 autonomous regions and 4 municipalities directly under the Central Government of the People's Republic of China (except Hong Kong SPECIAL Administrative Region, Macao Special Administrative Region and Taiwan);

For the subsequent purchaser or transferee, no matter in which country or region he/she purchased PhiCleaner, he/she must return to the Warranty area in the hinterland of China to obtain the warranty service.

Unless in the above areas outside the Kwunphi authorized certification of the local service center, and the service center assumes local legal responsibility, then Kwunphi transfers the legal rights and obligations of the "New PhiCleaner Limited Quality Assurance" to the local service center.

10.5 Multiple warranty terms

The warranty terms and conditions contained in this " New PhiCleaner Limited Quality Assurance" may vary from one part or system to another. Warranty for a particular part or system is limited to the scope of warranty set forth in the Warranty section and other terms of this " New PhiCleaner Limited Quality Assurance" .

10.6 Restrictions and disclaimers

Unless otherwise provided by national laws and regulations, this " New PhiCleaner Limited Quality Assurance" is the only express warranty that applies to your PhiCleaner. Remedies under this " New PhiCleaner Limited Quality Assurance" or any implied warranty are limited to necessary repairs, replacement of parts, replacement of PhiCleaner or refund of PhiCleaner. Shenzhen Kwunphi Robot Co., LTD. does not authorize any person or entity to establish any other obligations or responsibilities on its behalf in connection with this " New PhiCleaner Limited Quality Assurance" . Subject to applicable laws and regulations, the Kwunphi Co.,LTD reserves the right to repair or replace parts or use new (including remanufactured) parts in its sole discretion.

10.7 Rights granted by Chinese law

You have certain rights under this " New PhiCleaner Limited Quality Assurance" . You may have other rights in accordance with applicable PRC laws and regulations.

10.8 Transfer of ownership

Subject to the limitations set forth in this " New PhiCleaner Limited Quality Assurance" , this " New PhiCleaner Limited Quality Assurance" may be transferred, free of charge, to any person who legally acquired ownership of PhiCleaner after the first purchaser (the "Subsequent Purchaser").

10.9 Who may request performance of this " New PhiCleaner Limited Quality Assurance" ?

Subject to the laws of the People's Republic of China, the first purchaser or subsequent purchaser of a new PhiCleaner purchased in the Kwunphi Co.,Ltd the hinterland of China Warranty Area and registered or owned in the name of the first purchaser or subsequent purchaser may require performance of this " Kwun Limited warranty policy" under the terms of this " Kwun Limited warranty policy" .

10. New PhiCleaner Limited Quality Assurance

10.10 Start and end time of warranty period

The "New PhiCleaner Limited Quality Assurance" comes into effect from the date of first use or the end of a silent period of more than 6 months from the factory. The warranty period is 1 year or 1,000 kilometers, whichever comes first. Where parts are repaired or replaced in accordance with this "New PhiCleaner Limited Quality Assurance", or PhiCleaner is replaced, the warranty period for the repaired or replaced parts is limited to the remainder of the warranty period for the corresponding part in this "New PhiCleaner Limited Quality Assurance", unless otherwise provided by applicable law.

10.11 Warranty scope

This "New PhiCleaner Limited Quality Assurance" contains detailed information on repairs, parts replacement, PhiCleaner replacement and refund of PhiCleaner. The details are as follows. All remedies provided to you under this "New PhiCleaner Limited Quality Assurance" are repairs or replacement of parts for quality problems within the scope of warranty or replacement of your PhiCleaner or refund of PhiCleaner under certain limited circumstances as required by Chinese laws and regulations. The Kwunphi has the discretion to use new parts (including remanufactured parts) for repairs. All parts or other components replaced by Kwunphi in accordance with this "New PhiCleaner Limited Quality Assurance", as well as PhiCleaner returned to bugs or PhiCleaner replaced by Kwunphi co., Ltd, are Kwunphi's exclusive property, unless otherwise provided by applicable laws.

10.12 Use of personal contact information

If you obtain services under this warranty, you authorize Kwunphi to store, use and process work log information as well as your contact information, including name, phone number, address and email address. Monsters can use this information to carry out services under this Policy. We may contact you to ask if you are satisfied with our warranty service or to notify you of any product recalls or safety issues. To achieve the above objectives, you authorize Kwunphi to transfer your information to any country or region in which we do business and to make it available to organizations acting on our behalf. We may also disclose this information if required by law.

10.13 PhiCleaner Three packs of limited warranty / Repair

The free warranty service must meet the following conditions:

- √ The products purchased from the buyer are normally used within the specified warranty period and have non-man-made performance faults;
- √ No unauthorized disassembly, disassembly or addition other than the official instructions, other non-human caused fault;
- √ Provide valid proof of purchase, receipt and tracking number.

The following circumstances do not belong to the free product warranty service:

- × Man-made collision and drop accidents not caused by quality problems of the product itself;
 - × Damage caused by unauthorized modification, dismantling and shell opening guided by unofficial instructions;
 - × Damage or water inflow caused by improper installation, use and operation not in accordance with the instructions;
 - × Damage caused by customer's own repair of assembly parts without official instructions;
 - × Damage caused by circuit modification guided by unofficial instructions, or improper matching of battery pack and charger;
 - × Damage caused by all operations not operated in accordance with the product instructions;
 - × Damage caused by operation in harsh environment, such as wind, rain, sand, etc.;
 - × Damage caused by operation in case of mutual interference with other wireless devices, such as transmitter, graph signal, Wi-Fi signal interference, etc.;
 - × Damage caused when working at a face with a deviation beyond the designated inclination Angle;
 - × Damage caused by forced operation in the case of aging or damage of parts;
 - × Damage caused by reliability and compatibility problems when used together with third-party components certified by non-weird insects;
 - × Damage caused by insufficient discharge when the power is low or the battery with quality problems is used;
- Signs of machine serial number, factory label and other marks being torn or altered;
- × Failed to ship the item within 7 calendar days after contacting monster to confirm warranty service.

10.13 PhiCleaner Three packs of limited warranty / Replacement or Return

You can apply for return if you meet the following conditions:

- √ Within 7 calendar days after you receive the goods, the outer packaging, accessories, gifts and instructions of the products are complete, and there is no artificial damage, not activated use, will not affect the second sale;
- √ Within 7 calendar days of your receipt of the goods, you find that the product has a performance fault that is not human-caused.

10. New PhiCleaner Limited Quality Assurance

10.13 PhiCleaner Three packs of limited warranty / Replacement or Return

Kwunphi reserves the right to reject your return request under the following circumstances:

requests for return more than 7 calendar days after receipt of goods;

- × The returned goods are incomplete, the outer packing, accessories, gifts, instructions are incomplete, or the appearance is damaged due to artificial reasons;
- × Failing to provide legal purchase vouchers or documents, or forging or altering the documents;
- × Non-product quality problems caused by the collision, falling, and artificial personal modification, into foreign matter (water, oil, sand, etc.), incorrect installation, not according to the instructions of the use and operation caused by the quality of goods;
- × Tear and alter labels, machine serial numbers, waterproof marks, security marks, etc.;
- × Products damaged by unavoidable factors such as fire, flood, lightning strike, traffic accident and other irresistible forces;
- × After contacting monster to confirm return service, the corresponding item is not mailed within 7 calendar days;

If one of the following conditions is met, a replacement can be requested:

- √ Within 15 calendar days after receiving the goods, you find that the products are damaged in the course of transportation and can provide the proof of damage provided by the transportation company;
- √ Within 15 calendar days of receipt of the goods, you find that the product is substantially inconsistent with the description of the original product in one or more important aspects;
- √ Within 15 calendar days of your receipt of the goods, you find a performance fault that is not human-caused.

The Kwunphi has the right to refuse your request for replacement under the following circumstances:

- × Requests for replacement more than 15 calendar days after receipt of goods;
- × Failing to provide legal purchase vouchers or documents, or forging or altering the documents;
- × Incomplete replacement of goods, or artificial appearance caused by damage;
- × Detected by the technical support department of strange insects, there is no quality problem itself;
- × Non-own quality problems caused by the collision, falling, and artificial personal modification, into foreign matter (water, oil, sand, etc.), incorrect installation, not according to the instructions of the use and operation caused by the quality of goods;
- × Tear and alter labels, machine serial numbers, waterproof marks, security marks, etc.;
- × Products damaged by unavoidable factors such as fire, flood, lightning strike, traffic accident and other irresistible forces;
- × After contacting monster to confirm the replacement service, the corresponding item is not mailed within 7 calendar days;
- × Goods damaged due to transportation propose replacement of goods but fail to provide the certificate of goods damaged issued by the transportation company;

10.13 PhiCleaner Three packs of limited warranty / Pay for repairs and related

Different countries purchase PhiCleaner, in view of the product or the use of different conditions, during the warranty period of return and replacement and warranty services will be different.

For details, please see <http://www.Kwunphi.com/cn/service/policy>.

- ※ You need to send the problem back to PhiCleaner. After receiving the problem machine, the Kwunphi will conduct fault detection to PhiCleaner to determine the responsibility for the problem. If the quality defect belongs to PhiCleaner, the Kwunphi shall bear the testing fee, material fee, labor fee and express fee.
- ※ If PhiCleaner does not meet the conditions of free maintenance after testing, you can choose to pay for repair or send it back to the original machine.
- ※ If the problem of the machine is not within the warranty scope (such as man-made damage to the machine), the Kwunphi will charge the corresponding testing fee, replacement fee, testing fee, labor fee and express fee.
- ※ PhiCleaner Maintenance may cause data loss, so you must back up data in advance.
- ※ If the battery is seriously damaged, such as damaged cell, bulge, leakage and so on, it will be scrapped and will not be returned.
- ※ In view of the differences between PhiCleaner's versions, PhiCleaner does not support global co-guarantee, and can only provide warranty service in the designated regional repair center of the Kwunphi. If you need to designate a repair center in the non-purchase area, the Kwunphi will be handled according to the local stock situation and only provide a paid service.
- ※ If the address you provide is wrong or the recipient refuses to accept, the customer shall bear the loss caused thereby.

10. New PhiCleaner Limited Quality Assurance

10.13 PhiCleaner Three packs of limited warranty / Pay for repairs and related

- ※ If the express cannot be delivered or returned to the bug after being rejected, the bug will take care of it and the storage fee will be calculated from the date of return. Due to the corresponding requirements of the storage environment, the storage charge standard is: 100 yuan/day. When the storage charge is equivalent to the residual value of PhiCleaner, the Kwunphi will have the right to dispose of the PhiCleaner. (PhiCleaner Residual value calculation method: residual value = original selling price - this maintenance cost)
- ※ If you wish to send PhiCleaner overseas, you need to obtain the approval of the worm, and the resulting customs duties and customs clearance costs should be borne by you.
- ※ If PhiCleaner is flooded, the performance of PhiCleaner will be seriously affected, and there is no maintenance value, so the Kwunphi can not provide maintenance service, we will provide replacement PhiCleaner service, please note and send it back as appropriate.
- ※ PhiCleaner Please properly dispose the personalized items and decorations (including but not limited to PhiCleaner decorative stickers, UAS stickers, paint and spray paint, etc.) attached to the original PhiCleaner before sending and repairing, the Kwunphi will not be responsible for the damage and loss of the personalized items and decorations.
- ※ In order to ensure your normal rights and interests, please check whether PhiCleaner is in good condition (whether there is any damage caused by logistics and other reasons) when signing for the goods. If PhiCleaner is abnormal, please feedback to us within 7 calendar days from the date of receipt; Otherwise, it will be regarded as your default PhiCleaner without damage and normal performance. According to the claim management process of the logistics party, if the goods are damaged due to logistics transportation, they should contact the Kwunphi within 24 hours.

10.14 Exclusions and Limitations / Quality assurance restrictions

This "New PhiCleaner Limited Quality Assurance" does not cover direct or indirect damage or failure to PhiCleaner caused by normal wear and tear or degradation, abuse, misuse, negligence, accident, improper maintenance, operation, storage or transportation, including but not limited to:

- × After discovering the quality problem under this "New PhiCleaner Limited Quality Assurance", fail to send PhiCleaner to the Kwunphi Service Center or the repair enterprise authorized by the Kwunphi, or fail to repair or repair in a manner recommended by the Kwunphi;
- × collision, falling and burning accidents caused by non-product quality problems;
- × Damage caused by unauthorized modification, dismantling and shell opening guided by unofficial instructions;
- × Damage caused by incorrect installation, use and operation not in accordance with instructions;
- × In the absence of official instructions, the customer repairs the damaged parts by himself;
- × Damage caused by circuit modification guided by unofficial instructions, or improper matching of battery pack and charger;
- × Damage caused by all operations not operated in accordance with the product instructions;
- × Damage caused by operation in harsh environment, such as wind, rain, sand, etc.;
- × Damage caused by operation in case of mutual interference with other wireless devices, such as transmitter, graph signal, Wi-Fi signal interference, etc.;
- × Damage caused when working at a face with a deviation beyond the designated inclination Angle;
- × Damage caused by forced operation in the case of aging or damage of parts;
- × Damage caused by reliability and compatibility problems when used together with third-party components certified by non-weird insects;
- × Damage caused by insufficient discharge when the power is low or the battery with quality problems is used;
- × Uninterrupted operation of the product;
- × Data loss or damage caused by the product;
- × Failure or damage caused by any third party products;
- × Change or remove the product or component with the identification label.

10.14 Exclusions and Limitations / Other restrictions and exclusions

Apart from the above exclusions and limitations, this "New PhiCleaner Limited Quality Assurance" does not cover:

The Kwunphi is only liable for loss or damage to the product if: the product is already in Kwunphi possession; Or the product is on the way to be transported by the Kwunphi.

Kwunphi is not responsible for the loss or disclosure of any data contained in the product, including confidential, proprietary or personal information.

10. New PhiCleaner Limited Quality Assurance

10.14 Exclusions and Limitations / Other restrictions and exclusions

For the following situation, regardless of the provisions of this “ New PhiCleaner Limited Quality Assurance” is any benefits to its fundamental purpose, no matter the claim is based on contract, warranty, negligence, strict liability or other responsibility theory, strange insect and its associated enterprises, suppliers, distributors, or service provider shall not be responsible for, if already know the possibility of these situations happens is no exception:

- 1) Claim for damages from a third party;
- 2) Loss, damage or disclosure of your data;
- 3) Special, incidental, indirect or consequential damages, including but not limited to loss of profits, business revenue, goodwill or anticipated savings.

The above restrictions do not apply to damages for personal injury, including death, and damage to real and tangible property for which bugs are legally liable. Some countries or territories or jurisdictions do not allow any screening or limitation for incidental or consequential damages, and therefore the above exclusion or limitation may not apply to you.

10.15 Claims for damages

Kwunphi hereby disclaims all indirect, incidental, special and consequential losses arising out of or in connection with PhiCleaner, including but not limited to between Kwunphi service center of transportation, PhiCleaner loses value, time loss, revenue loss, the loss due to unavailable PhiCleaner, personal or commercial property damage, inconvenience, or worse, spiritual pain or damage, loss of business (including but not limited to profit or loss of income), bus, car rental, maintenance call, accommodation, And telephone, fax and mail charges and other incidental charges. The full liability of Kwunphi and its affiliates, suppliers, distributors or service providers is limited to the direct loss you actually suffer, no more than the amount you paid for the products, regardless of the cause. Within the scope of the law, whether your claim is based on contract, tort (including negligence and gross negligence), breach of warranty terms or conditions, misrepresentation (whether in negligence or other), except the above restrictions and terms and conditions are applicable, even if the Kwunphi has been told the possibility of such damage or such damage can be predicted reasonably.

11. Warranty and after-sales service

Warranty and after-sales service			
Products such as fault, refer to the “ New PhiCleaner Limited Quality Assurance” ‘s quality assurance scope, Shenzhen Kwunphi Robot Co., Ltd. to give consumers the corresponding maintenance or replacement guarantee. This warranty does not cover any damage caused by improper use, connection, or maintenance, accident or abuse by others.			
Please provide the following information when contacting warranty service			
Product model		Full name	
Address and telephone number		Purchase date	
Problem description			

If you have any doubts or questions about this product, please contact our customer service hotline
Tel: 400-878-6861
Email address: service@kwunphi.com

www.kwunphi.com